



MODEL NUMBER: XTA902-1-0-GB-XX

IMPROX TA

ImproX (TA) Time Attendance Terminal INSTALLATION MANUAL

SPECIFICATIONS

Read/Write Capability	Slim Tags (Read Only), Omega Tags (Read Only), WriTag 128 (Read/Write) and WriTag 2048 (Read/Write).	
Working Environment	Designed to work in an indoor (dry) environment similar to IP50. The Terminal is, therefore, not sealed against water.	
Input Voltage	10 V DC to 30 V DC.	
Power Requirements	Current (mA)	Power (W)
Input Voltage 10 V DC	250	2.5
Input Voltage 30 V DC	83	2.5
Power Output		
Remote Reader Port	5 V DC \pm 0.1 V is supplied to power the single Remote Reader connected. A maximum of 150 mA can be supplied from this Port.	
Third-party Reader Port	5 V DC \pm 0.1 V is supplied to power the single Reader connected to this Port. A maximum of 50 mA can be supplied from this Port.	
Relays		
Relay Output	2 Relays, 1 x SPDT (NO, NC and Common) contact set.	
Relay Contact Ratings	3 A at 24 V DC, 3 A at 125 V AC.	
Digital Inputs		
Type	4 Dry-contact Inputs.	
Protection Range	+80 V to -80 V surge, +50 V to -50 V continuous.	
Configuration	Software configurable in Normal Sensing Mode and in End of Line (EOL) Sensing Mode.	
Frequency	125 kHz	

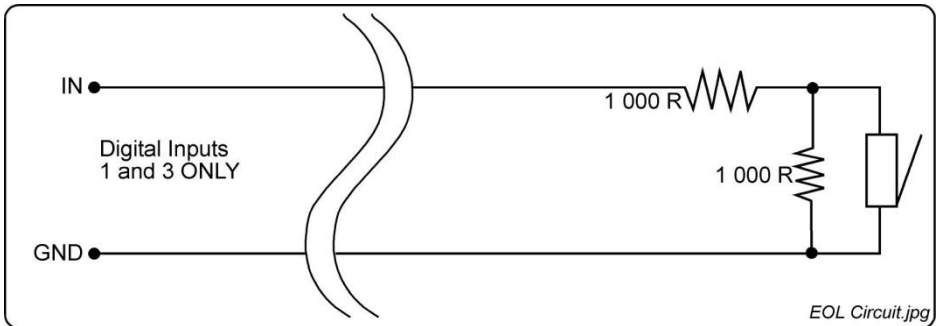

Figure 1: End of Line (EOL) Sensing Circuit

NOTE: *End of Line (EOL) Sensing enables the Terminal to raise an alarm when somebody tampers with the circuit (that is, cutting or shorting the wires) between the Digital Input (IN 1 and IN 3) and GROUND (GND). In other words the Terminal distinguishes between tampering on the circuit, and the door being in an actual 'Normally Open' state.*

By placing Resistors into the circuit between the Digital Input (IN 1 and IN 3) and GROUND (GND), the Terminal's Digital Input monitors a constant resistance through the circuit. When the circuit is tampered with, the Resistors are bypassed; the Terminal detects the resistance change raising an alarm.

Buzzer

Volume and Tone..... Single tone, with a 4-step adjustable volume.

Status Indicators

Status LED..... Bi-colour Red or Green LED (externally visible). The functions are application specific.
 Incoming RS485 Data..... Flashing Green LED (internally visible).
 Outgoing RS485 Data..... Flashing Red LED (internally visible).

Liquid Crystal Display (LCD)

Characters 16 Characters by 1 line.
 Character Set..... English, Katakana.
 Contrast Software adjustable in 8 discrete steps via the Communications Protocol.
 Back-lighting..... Permanently on.

Keypad

Buttons 4 Buttons, used for entering Reason Codes.
 Back-lighting..... Permanently on.

Blank Space

INSTALLATION INFORMATION

Accessories

Find the following when unpacking the ImproX TA Terminal:

- An ImproX (TA) Time Attendance Terminal, supplied in a Dark Grey ABS Plastic housing. The housing consists of the Front Cover (including the Liquid Crystal Display (LCD)) and the Base (Backing Plate). The Front Cover and Base are held together with two lugs, one at each end.
- Four (black) Polymate Screws (2.2 mm x 7.4 mm) Countersunk. (These are supplied to firmly attach the Terminals Front Cover to the Base).

CAUTION: DO NOT use the Metal-oxide Varistors (25 Vrms, 500 A, 77 V max clamping) with mains power applications.

- Two Metal-Oxide Varistors, 25 Vrms, 500 A, 77 V max clamping.
- Two Brass Wood Screws (3.5 mm x 25 mm).
- Two Wall Plugs (7 mm).
- An extra Fixed Address Label.

General

Remember the following when installing the ImproX TA Terminal:

Communications Distance

The RS485 communications distance between the ImproX TA and the ImproX Controller or Terminal, MUST NOT exceed 1 km (1 090 yd). Achieve this by using good quality screened twisted pair cable, with the screen EARTHED at one end.

Distance between the ImproX TA and its Remote (or Multi-mode Remote Reader)

The maximum cable distance between the ImproX TA and its Remote (or Multi-mode Remote Reader) MUST NOT exceed 10 m (33 ft). Achieve this by using good quality screened, twisted pair cable.

Distance between ImproX Units

To avoid mutual interference, install the ImproX units alongside each other at least 500 mm (20 in) apart.

Jumper Links

Long transmission lines or multiple “star” connections, may cause communication problems. Placing a Jumper Link across the jumper [TR1] in the LAST UNIT AT THE END OF THE CABLE RUN should solve the problem.

EARTH Connections

Communication Line

In electrically noisy environments it is necessary for the RS485 cable run to be EARTHED. This can be achieved by connecting the screen on the cable to the EARTH (ETH) connection terminal block on the RS485 Terminal Bus Port of the ImproX TA. Only one end of the cable must be connected to the EARTH (ETH), see Figure 4.

Power

It is good practice to EARTH the TA Terminal to a good EARTH point. Use a cable with a conductor cross sectional area of at least 0.5 mm² (0.0008 in²). Keep the EARTH line as short as possible. The EARTH line must be connected to the Negative (-) terminal of the Power Input terminal on the ImproX TA.

Arc Suppression

Snubber devices are recommended for EMF Flyback and Arc Suppression when driving an inductive load (for example, a Door Strike or Magnetic Lock) with the Relay, see Figure 2.

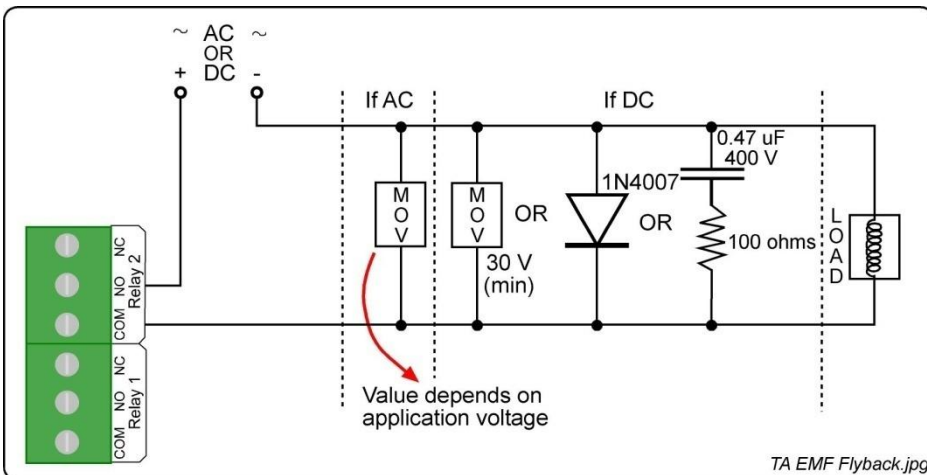

Figure 2: EMF Flyback and Arc Suppression

Mounting the Enclosure

CAUTION: Make certain that you mount the Terminal on a vibration-free surface.

Select the mounting position of the ImproX TA Terminal, considering accessibility, routing of wires and visibility of the externally visible LEDs and Liquid Crystal Display (LCD).













Secure the enclosure to the mounting surface, using two suitable screws and wall plugs (supplied), nuts and bolts or rivets.

Blank Space

DIP-switch Settings

The format selection for each type of device that can be connected to the Third-party Port is made by setting the internal DIP-switches as indicated in Table 1.

NOTE: Terminals 'A' and 'B' in Table 1 are on the Third-party Port Terminal Block.

DIP-switch Position	Format	Connections
0  DIP-switch 0 shows all the switches in the OFF position	No peripheral	N/A
1  DIP-switch 1 shows switches 2, 3 and 4 in the ON position	UHR900-0-1-GB-XX ImproX RF 4-channel UHF Receiver	Data line to terminal 'B'
2 	Magstripe ABA Track 2	Clock line to terminal 'B' Data line to terminal 'A'
3 	Barcode Code-39 with checksum	Data line to terminal 'B'
4 	Wiegand-26/37/40 and 44 (Sagem MA100, MA200 or MA300)	"0" Data line to terminal 'B' "1" Data line to terminal 'A'
5 	ImproX IR Infrared Receiver	Data line to terminal 'B'
6 	Barcode Code-39 without checksum	Data line to terminal 'B' (on the Third-party Port)
7 	Reserved	
8 	Motor Lock	
9 	Repeating (Pulse) Lock	
10 	Fail Safe/Fail Secure Solenoid Lock	
11 	UHR903-0-1-GB-XX ImproX RF 4-Channel Transmitter Buttons 1 and 2	Data line to terminal 'B'



DIP-switch Position	Format	Connections
12 	UHR903-0-1-GB-XX ImproX RF 4-Channel Transmitter Buttons 3 and 4	Data line to terminal 'B'
13 	Emergency/Unlock Mode Door Reporting Suppressed	Inputs 1 and 3 are allocated to the Door Open Sensor
14 	Wiegand open format (no parity checking) up to 48 bits	

Table 1: DIP-switch Settings

NOTE: Once the DIP-switch setting is modified reset the ImproX TA to acknowledge the new settings.

Blank Space

CONNECTING THE IMPROX TA TERMINAL

Figure 3 shows the positions of various components in the ImproX TA.

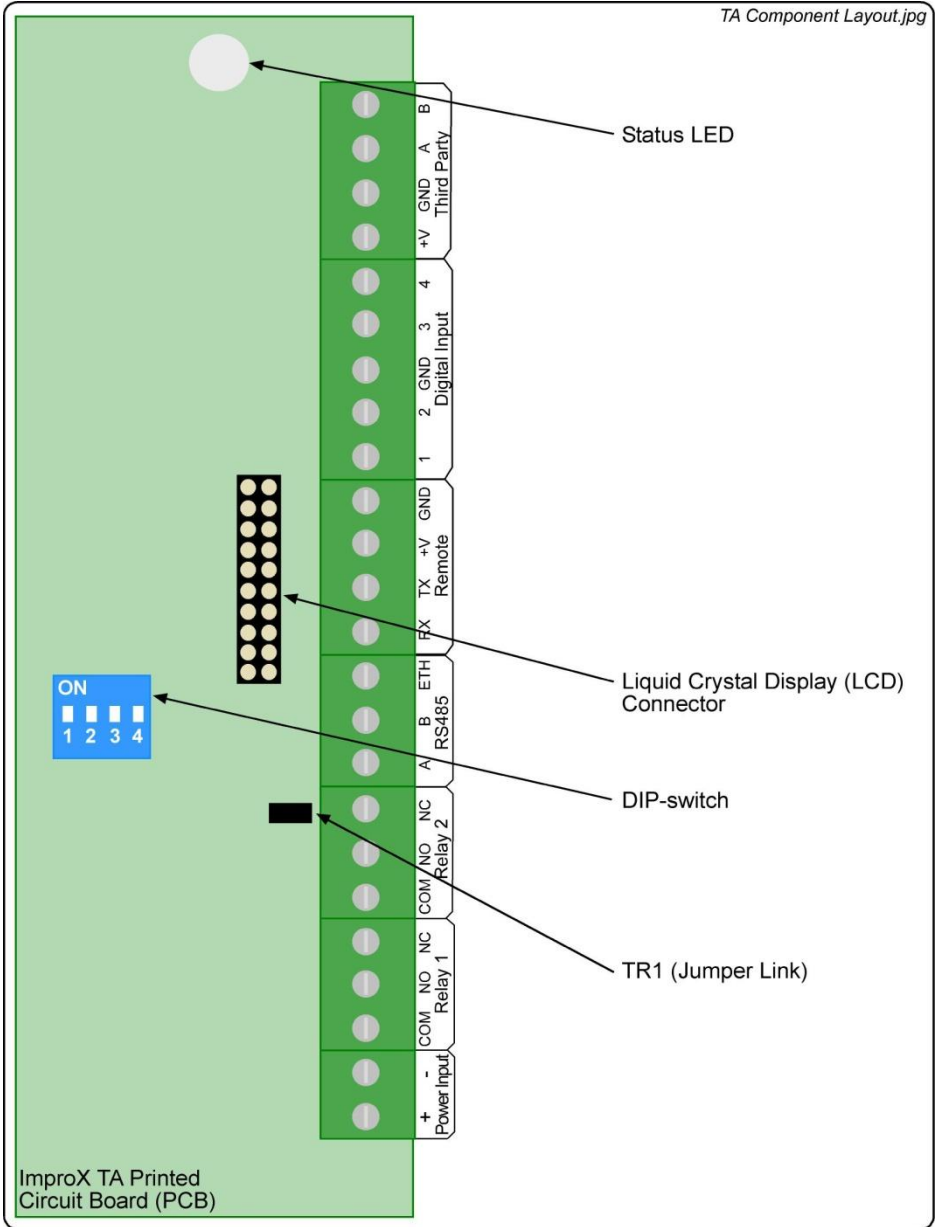

Figure 3: ImproX TA Component Layout Diagram

Figure 4 to Figure 8 shows detailed connection diagrams for the ImproX TA Terminal.

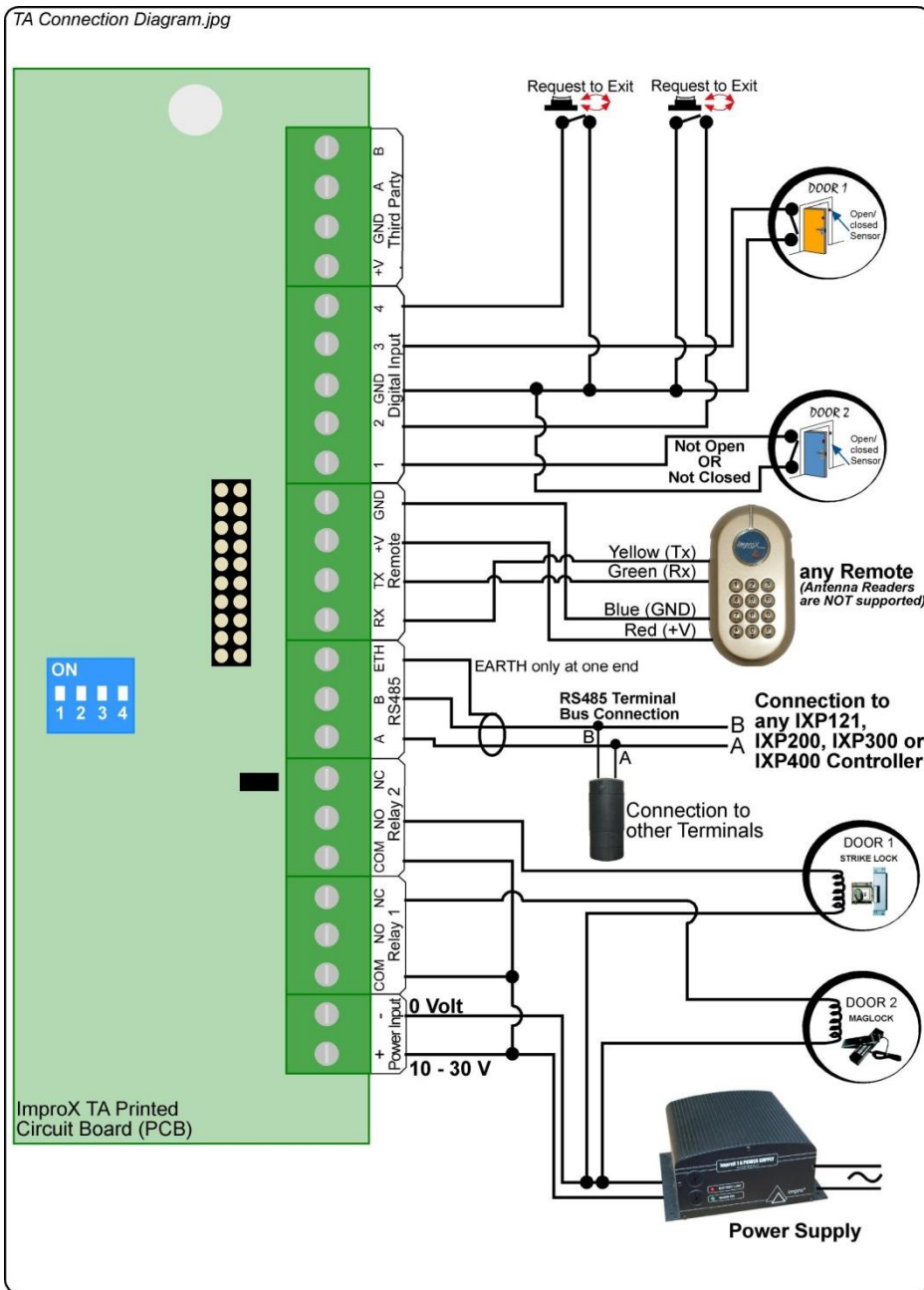
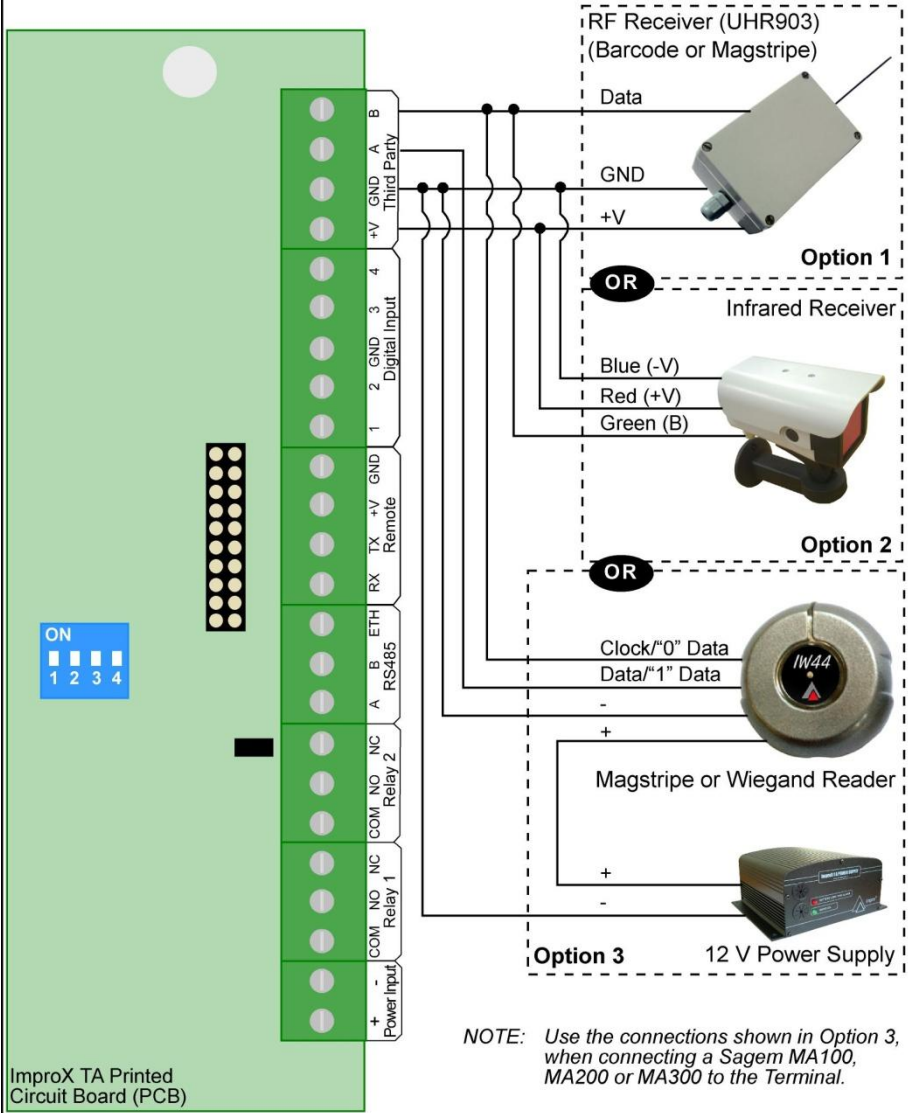

Figure 4: Typical ImproX TA Electrical Connections

NOTE: Option 1 shows the Terminal connected to Channel 1 of the ImproX RF. The Terminal can connect to any one of the Channels 1 to 4 (depending on the way the ImproX RF is used in the System).



NOTE: Use the connections shown in Option 3, when connecting a Sagem MA100, MA200 or MA300 to the Terminal.

Figure 5: Typical ImproX TA Third-party Port Electrical Connections

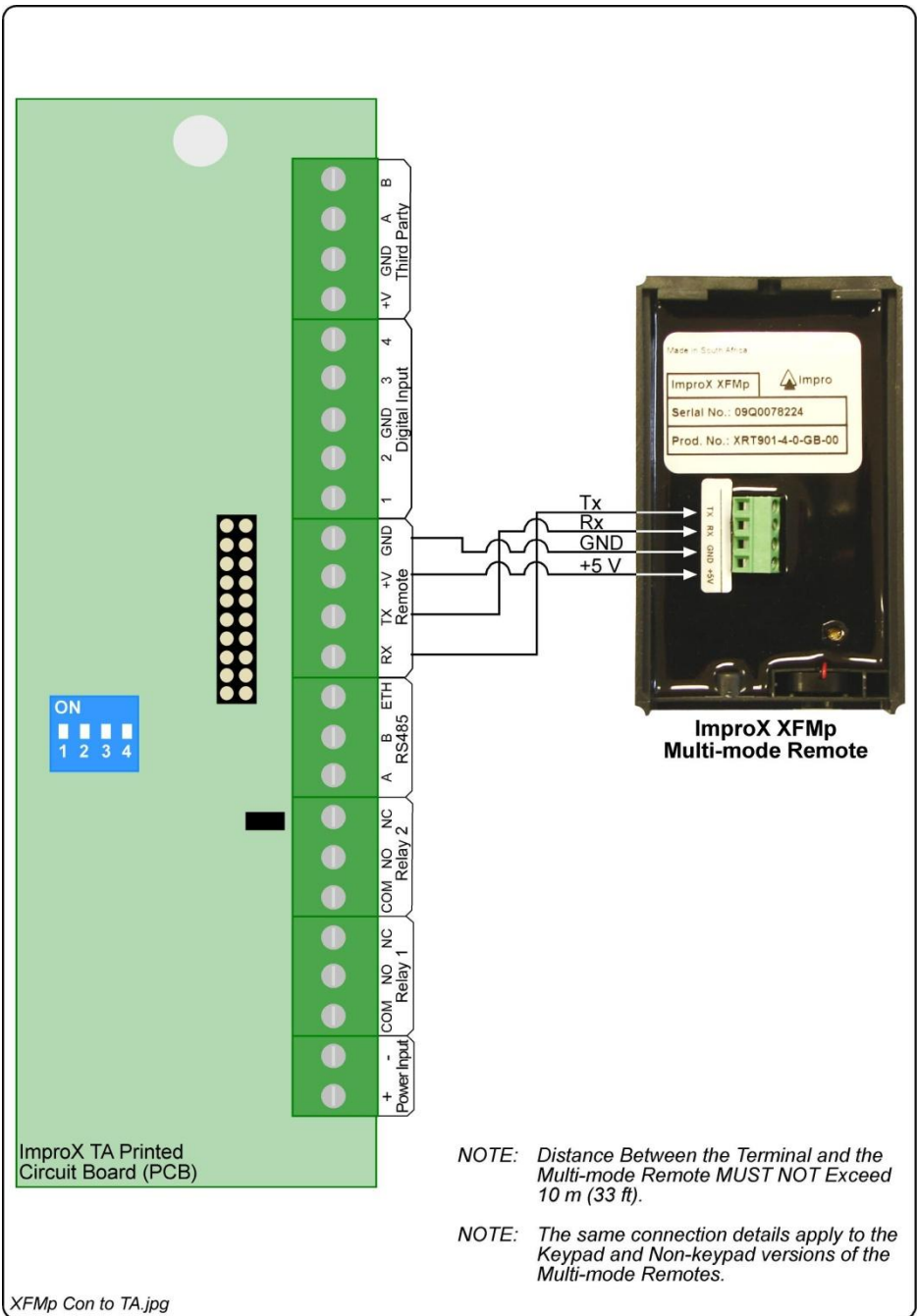

Figure 6: ImproX TA Connected to the Multi-mode Remote Reader

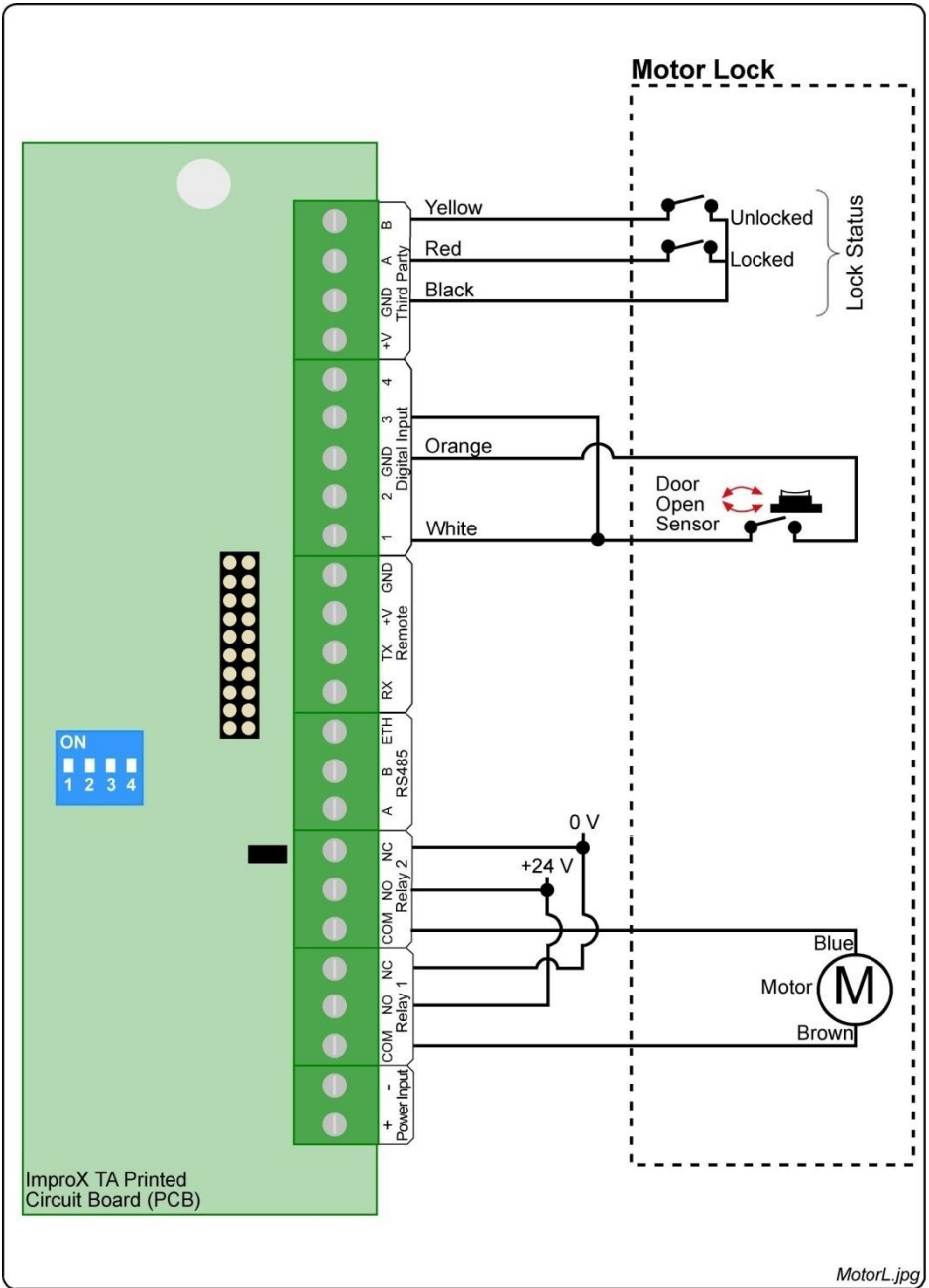

Figure 7: ImproX TA Terminal Connected to the MIWA AL3M Motor Lock

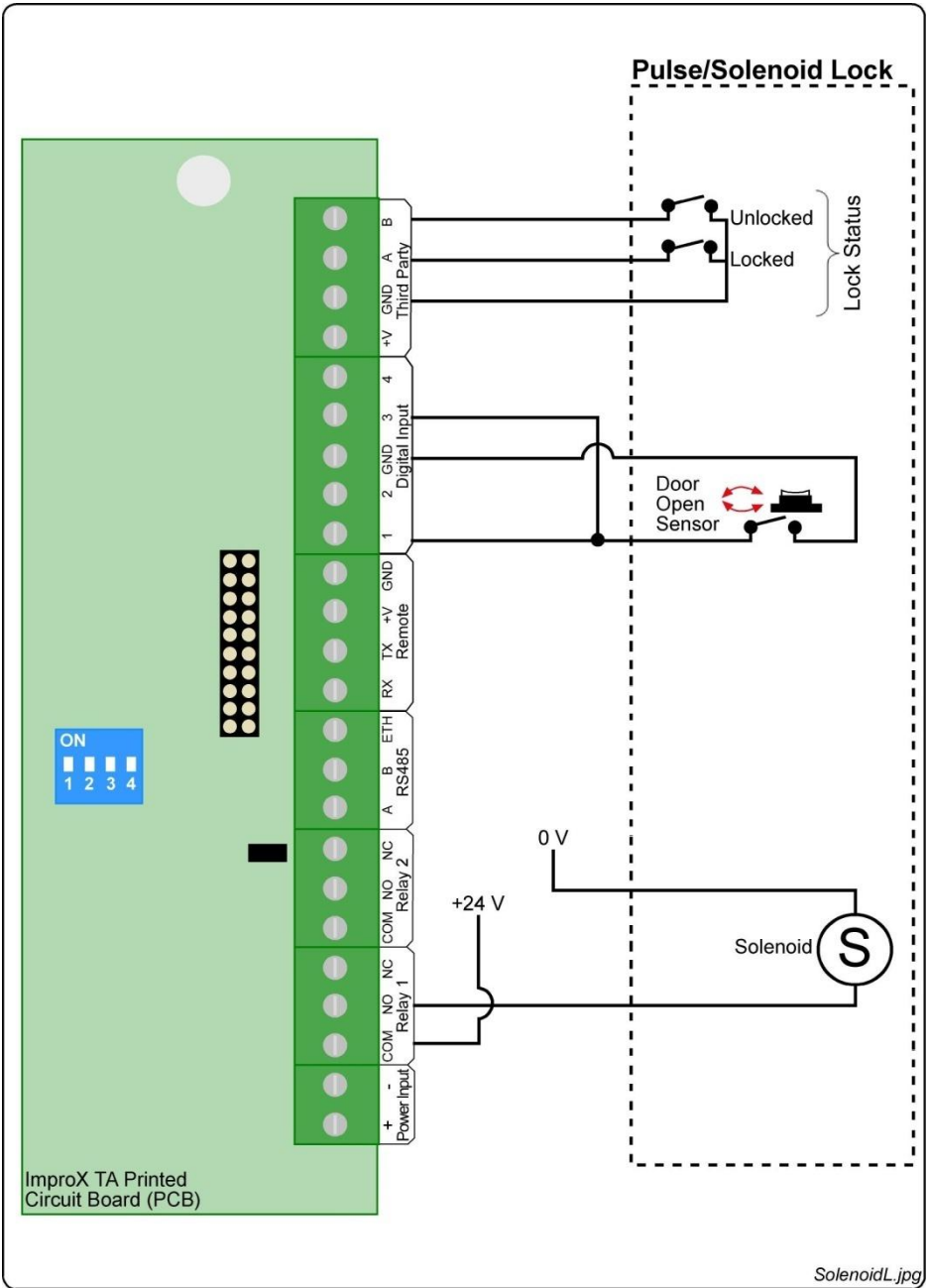

Figure 8: ImproX TA Terminal Connected to a Pulse or Solenoid Lock

Fixed Address Label

Once the ImproX TA is installed, sketch a rough site plan. Attach the loose (additional Fixed Address Label packaged with the Terminal) Fixed Address Label in the position of the Terminal on the sketched site plan. When the system installation is complete and all the units are represented on the site plan by their Fixed Address Labels, file the site plan for future reference.

GUARANTEE OR WARRANTY

CAUTION: We reserve the right to nullify the products guarantee or warranty where you have not properly installed the Metal-oxide Varistors.

This product conforms to our Guarantee or Warranty details placed on our Web Site to read further please go to www.impro.net.

USER NOTES

USER NOTES

USER NOTES



This manual is applicable to the ImproX (TA) Time Attendance Terminal, XTA902-1-0-GB-01. (The last two digits of the Impro stock code indicate the issue status of the product).

XTA302-0-0-GB-13

Issue 14

Dec
2007

ImproX TA\English Manuals\LATEST
ISSUE\ImprXTAT-inism-en-14.docx